

NEMA 4 Cabinet Cooler
 Continuous Operation
 Part No. 4725J



Product Description

NEMA 4 Cabinet Cooler System, 1700 Btu/hr., Continuous Operation without compressed air filter

Key Features

Air Consumption:	708L/m
Cooling Capacity:	1700Btu/hr
Sound Level:	82dBA
Material:	Aluminium

****All measurements based on 6.9Bar air pressure with optional muffler installed****

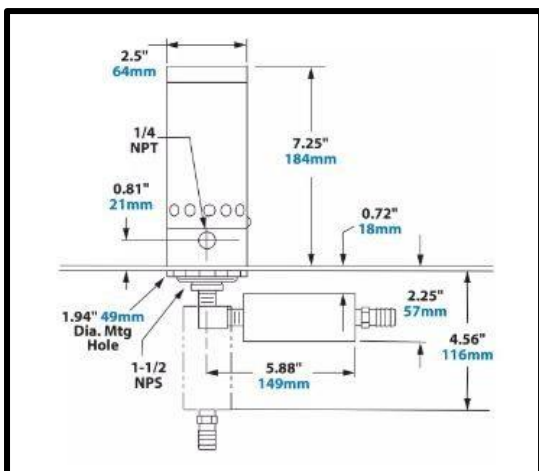

What's In The Bag?

Cabinet Cooler	4625
Cold Air Distribution Kit	4904

Optional Extras

Side Mount Kit	4907
Filter / Regulator	9003
Cold Muffler	4902