

Heavy Duty Vertical Toggle Clamp

Part No. GH-70725



Product Description

Heavy Duty Toggle Clamp Flat
Base Fixed Arm Size 700daN

Key Features

Overall Height:	221mm
Underarm Height:	48mm
Arm Length:	48mm
Holding Force:	700daN

Other Features

Arm Opens:	120°
Handle Opens:	180°
Weight:	1.235Kg

Material

Toggle Clamp:	Cast Iron
Spindle:	Zinc Plated Mild Steel
Handle:	uPVC

Whats In The Bag?

Toggle Clamp:	GH-70725
Spindle:	SA-121017

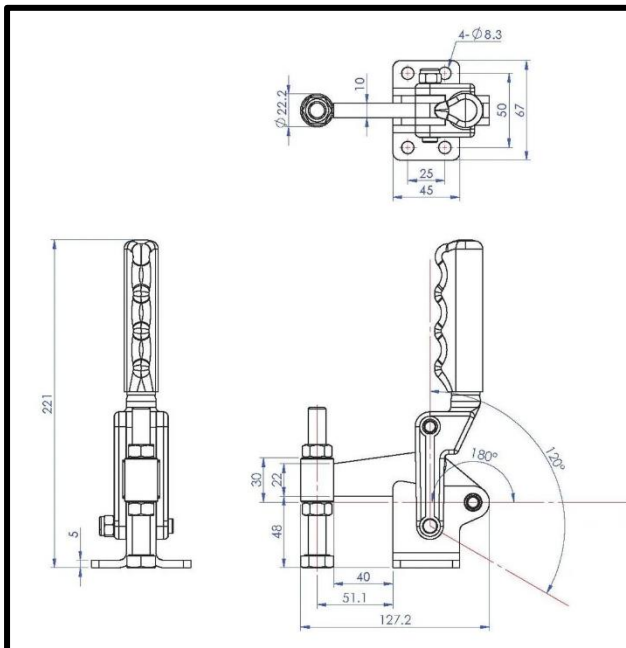

goodhanduk.co.uk

01908 221 151