



Product Description

2" Super Air Amplifier In Aluminium. 42mm Bore. Amplification Ratio 22-1

Key Features

Air Consumption:	439L/m
Amplification Ratio:	22:1
Output Air Volume:	9650L/m
Sound Level:	72dBA
Material:	Aluminium

****All measurements based on 5.5Bar****

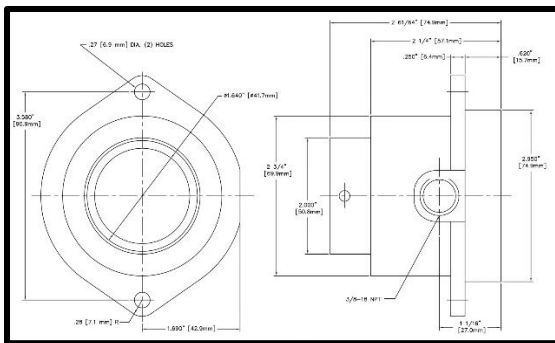

What's In The Bag?

Air Amplifier **120022**

Optional Extras

Filter **9003**
Shim Set **120322**