

GH-M25 , G Clamp 1" Model

Weight : 0.2Kg

Black drop forged steel with Swivel Spindle.

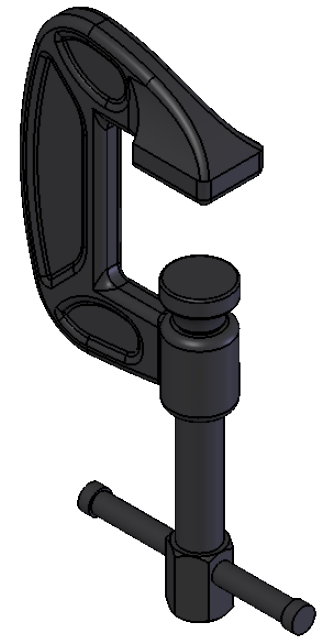
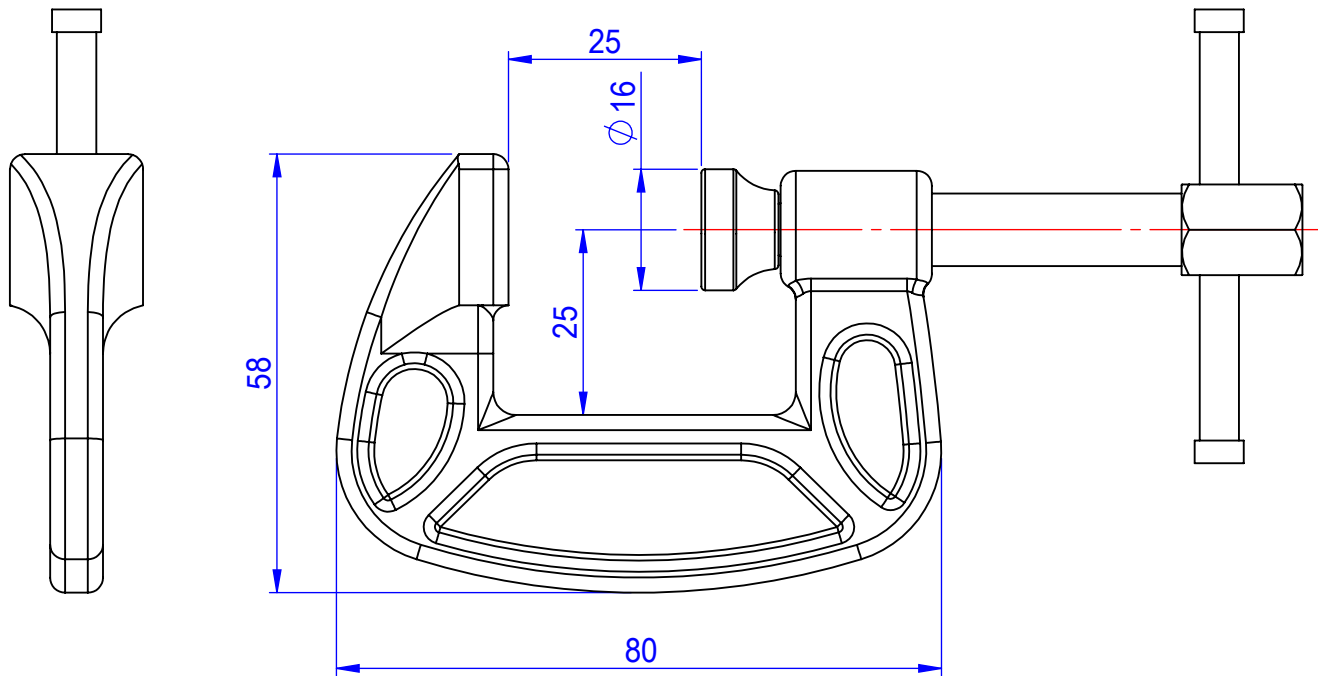

Unit:mm

Scale: 1:1

Good Hand UK Ltd

TITLE:

DWG NO. GH-M25

A4