

Super Air Knife In Aluminium
Part No. 110030



Manufacturing Intelligent Compressed Air Products Since 1983



Product Description

Super Air Knife In Aluminium 762mm Air Flow

Key Features

Air Flow Length: 762mm
Material: Aluminium
Inlets: 1/4" NPT Air Inlets On 2 Faces
Shim Installed: 0.05mm Thick
Mounting Holes: 1/4"-20 UNC

What's In The Bag?

Air Knife: 110030
Adaptor: 2 off 1/4" BSP to 1/4" NPT

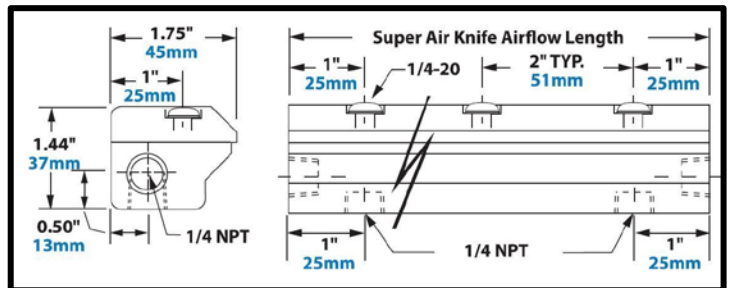
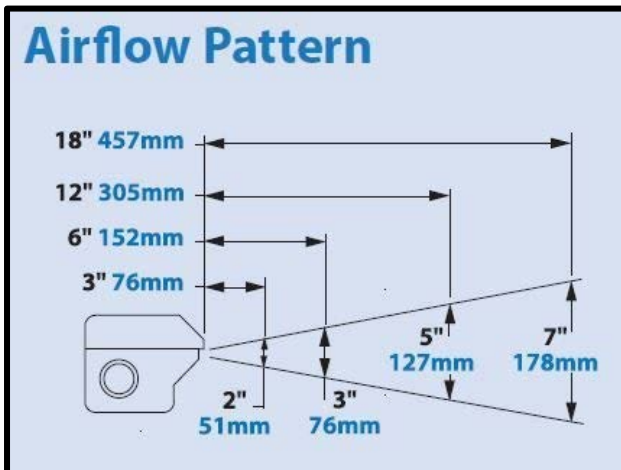

Performance Figures

Super Air Knife Performance with .002" (0.05mm) thick shim installed

Pressure Supply		Air Consumption per Inch (25mm)		Velocity @ 6" (152mm) from target		Sound Level @ 3' (914mm)	Force per Inch (25mm) @ 6" (152mm) from target	
PSIG	BAR	SCFM	SLPM	FPM	M/S	dBa	OUNCES	GRAMS
20	1.4	1.1	31	5,000	25.4	57	0.6	17
40	2.8	1.7	48	7,000	35.6	61	1.1	31
60	4.1	2.3	65	9,600	48.8	65	1.8	51
80	5.5	2.9	82	11,800	59.9	69	2.5	71
100	6.9	3.5	99	13,500	68.5	72	3.2	91

12" (305mm) Super Air Knife tested



goodhanduk.co.uk

01908 221 151