

NEMA 4 Cabinet Cooler Part No. 4780J



Product Description

NEMA 4 Dual Cabinet Cooler System, 5600 BTU/hr., Continuous Operation, without compressed air filter

Key Features

Air Consumption:	2266L/m
Cooling Capacity:	5600Btu/hr
Sound Level:	85dBA
Material:	Aluminium

****All measurements based on 6.9Bar air pressure with optional muffler installed****

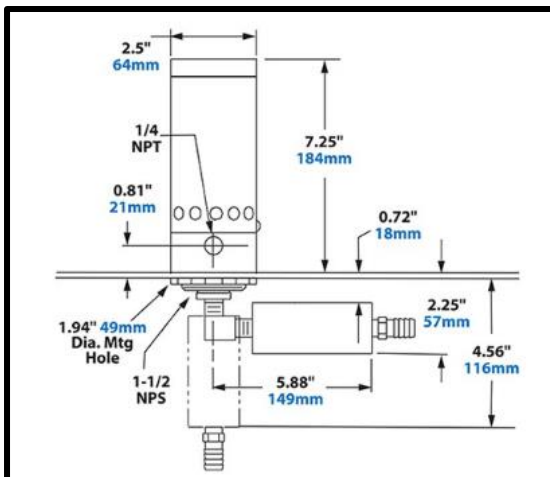

What's In The Bag?

2x Cabinet Cooler	4640
2x Cold Air Distribution Kit	4904
1x Dual Cabinet Cooler Kit	4908

Optional Extras

Side Mount Kit	4907
Filter / Regulator	9008
Cold Muffler	4902