

GH-M100 , G Clamp 4" Model

Weight : 1.4Kg

Black drop forged steel with Swivel Spindle.

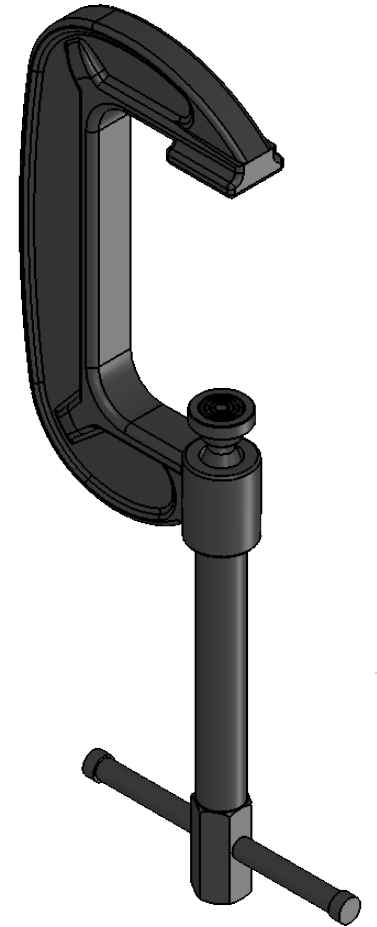
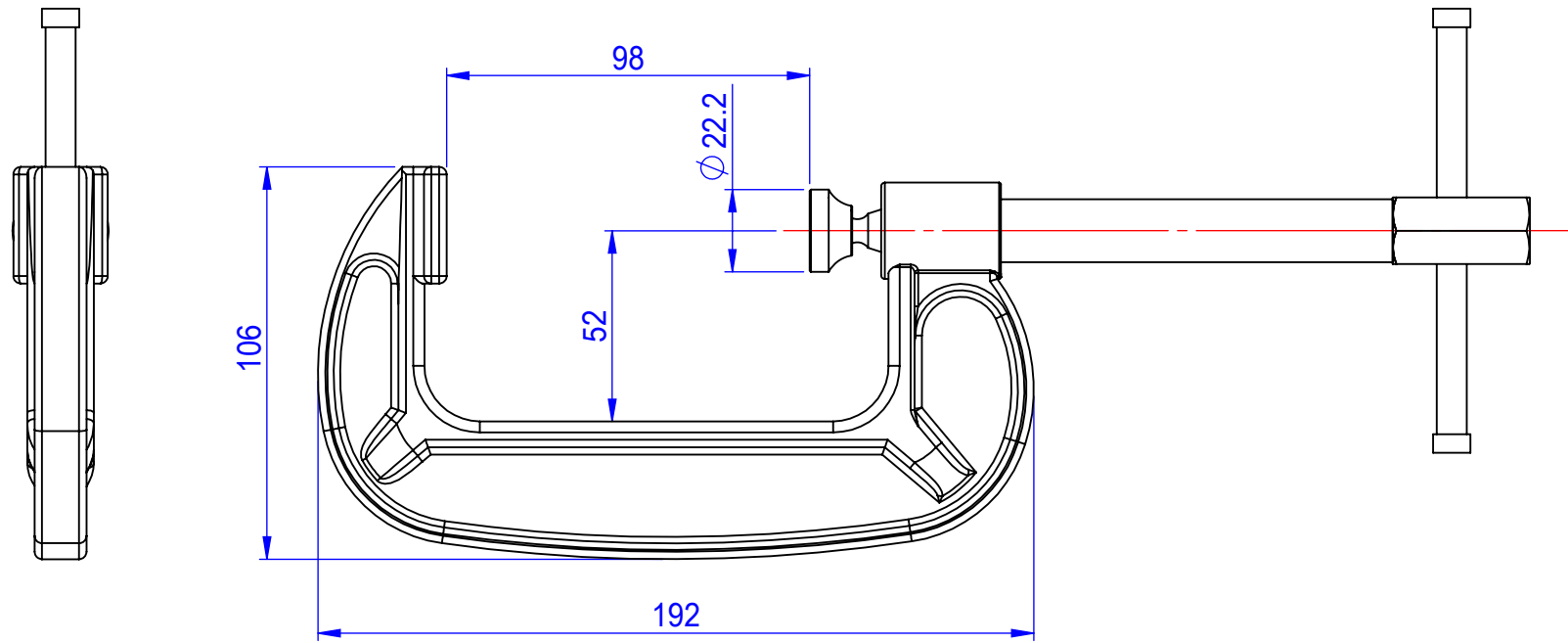

Unit:mm

Scale: 1:2

Good Hand UK Ltd

TITLE:

DWG NO. GH-M100

A4