

GH-M150 , G Clamp 6" Model

Weight : 3.17Kg

Black drop forged steel with Swivel Spindle.

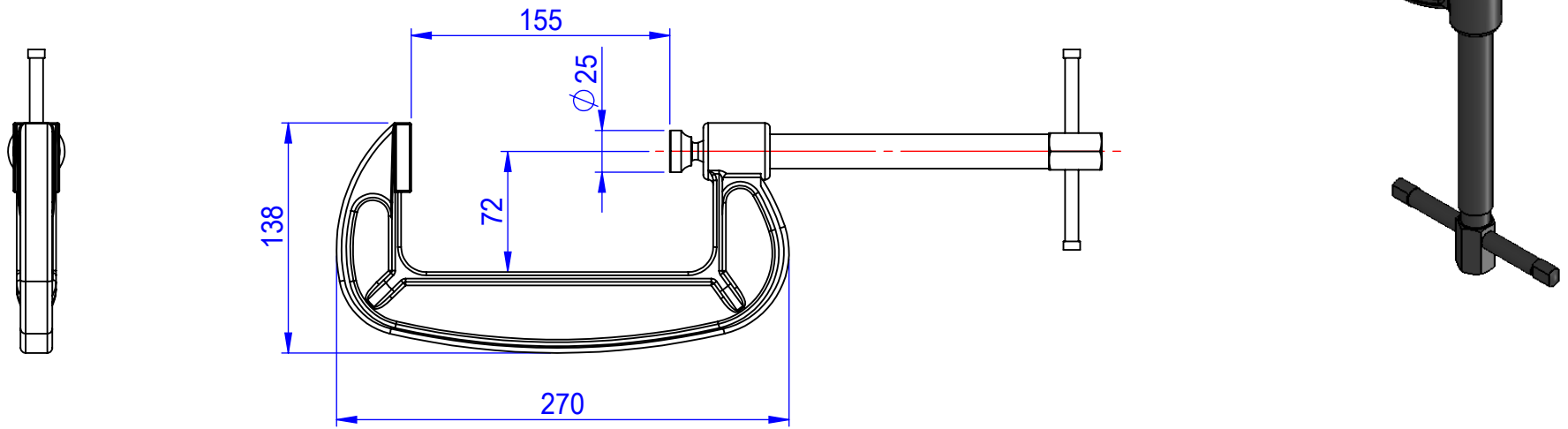

Unit:mm

Scale: 1:4

Good Hand UK Ltd

TITLE:

DWG NO. GH-M150

A4