

NEMA 4X Cabinet Cooler
 Continuous Operation
 Part No. 4730SSJ



Product Description

NEMA 4X Stainless Steel Cabinet Cooler System, 2000 Btu/hr., Continuous Operation without compressed air filter

Key Features

Air Consumption: 850L/m
Cooling Capacity: 2000Btu/hr
Sound Level: 84dBA
Material: Stainless Steel

****All measurements based on 6.9Bar air pressure with optional muffler installed****

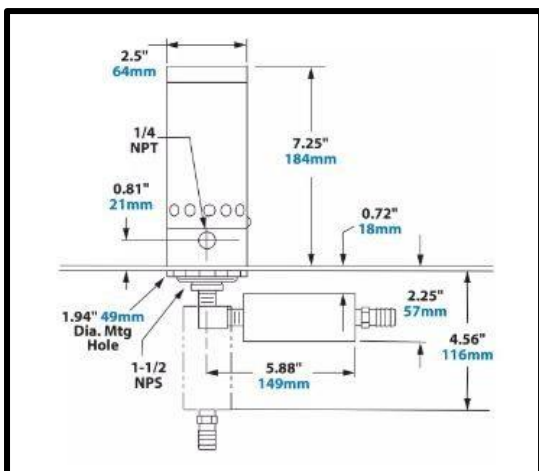

What's In The Bag?

Cabinet Cooler 4630SS
Cold Air Distribution Kit 4904

Optional Extras

Side Mount Kit 4907
Filter / Regulator 9003
Cold Muffler 4902