

NEMA 4 Cabinet Cooler
 Continuous Operation
 Part No. 4715J



Product Description

NEMA 4 Cabinet Cooler System, 1000 Btu/hr., Continuous Operation without compressed air filter

Key Features

Air Consumption: 425L/m
Cooling Capacity: 1000Btu/hr
Sound Level: 81dBA
Material: Aluminium

****All measurements based on 6.9Bar air pressure with optional muffler installed****

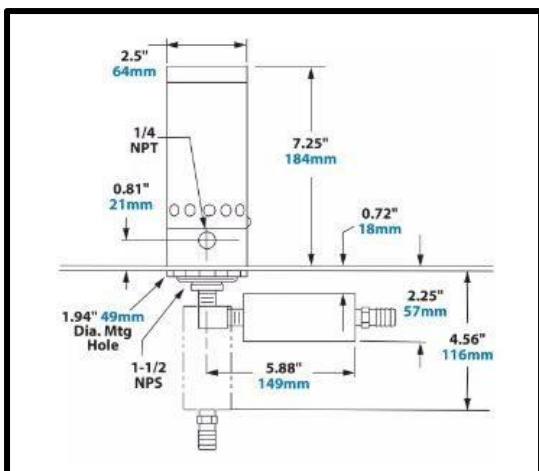

What's In The Bag?

Cabinet Cooler 4015
Cold Air Distribution Kit 4904

Optional Extras

Side Mount Kit 4907
Filter / Regulator 9003
Cold Muffler 4902