



Product Description

NEMA 12 Cabinet Cooler Only, 1000 Btu/hr, 1/4 NPT

Key Features

Air Consumption:	425L/m
Cooling Capacity:	1000Btu/hr
Sound Level:	81dBA
Material:	Aluminium

****All measurements based on 6.9Bar air pressure with optional muffler installed****

What's In The Bag?

Cabinet Cooler	4015
----------------	------

Optional Extras

Side Mount Kit	4910
Cold Air Distribution Kit	4904
Filter / Regulator	9003
Cold Muffler	4902

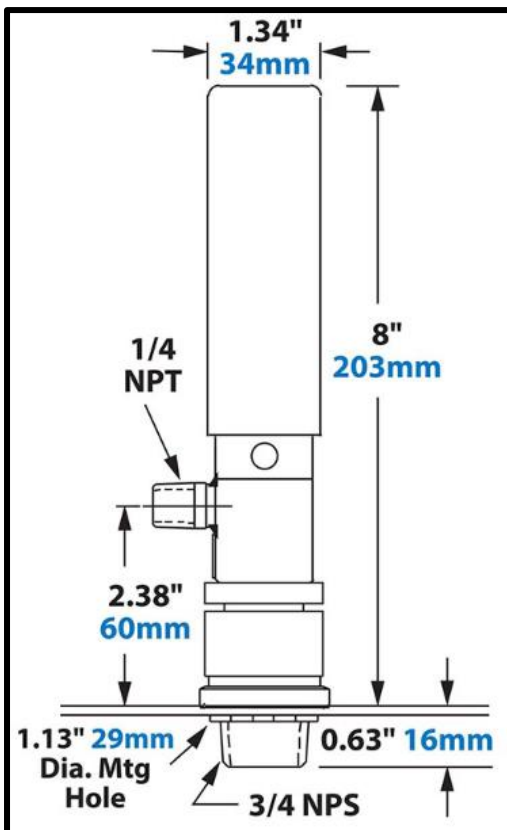

Supplied By

GH GoodHand UK

goodhanduk.co.uk

01908 221 151