

NEMA 4 Cabinet Cooler
With Thermostat
Part No. 4825



Product Description

NEMA 4 Cabinet Cooler System, with 120 VAC Thermostat Control, 1700 Btu/hr., compressed air filter included

Key Features

Air Consumption:	708L/m
Cooling Capacity:	1700Btu/hr
Sound Level:	82dBA
Material:	Aluminium

****All measurements based on 6.9Bar air pressure with optional muffler installed****

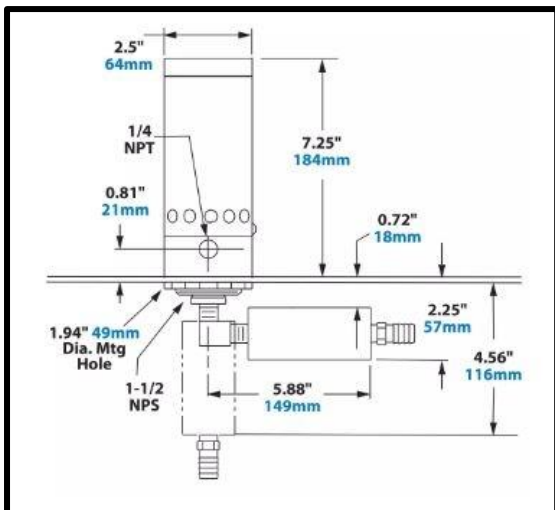

What's In The Bag?

Cabinet Cooler	4625
Cold Air Distribution Kit	4904
Thermostat	9017
120 VAC Solenoid Valve	9018
Air Filter	9004
Filter Mounting Bracket	900396

Optional Extras

Side Mount Kit	4907
----------------	------