

NEMA 4X Cabinet Cooler Part No. 4750SSJ



Product Description

NEMA 4X Stainless Steel Dual Cabinet Cooler System, 3400 BTU/hr., Continuous Operation, without compressed air filter

Key Features

Air Consumption:	1416L/m
Cooling Capacity:	3400Btu/hr
Sound Level:	84dBA
Material:	Stainless Steel

****All measurements based on 6.9Bar air pressure with optional muffler installed****

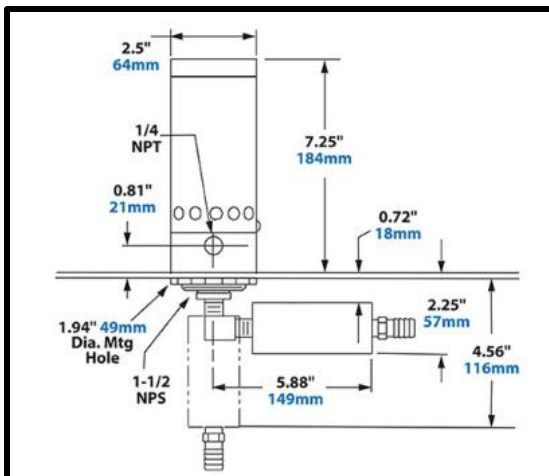

What's In The Bag?

2x Cabinet Cooler	4625SS
2x Cold Air Distribution Kit	4904
1x Dual Cabinet Cooler Kit	4908

Optional Extras

Side Mount Kit	4907
Filter / Regulator	9008
Cold Muffler	4902